

• a free pattern from • **oliver + s** • not for resale •

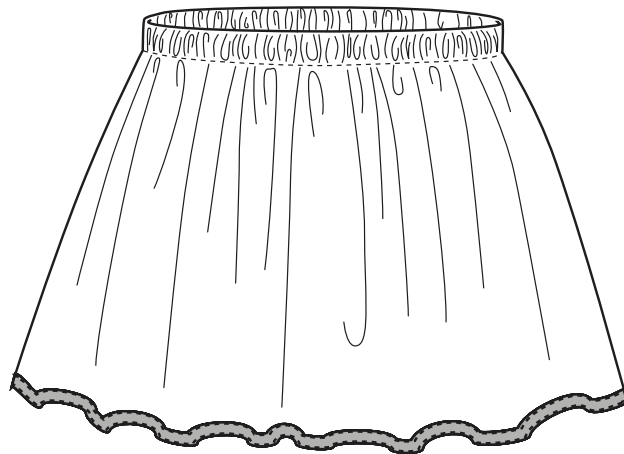

LAZY DAYS SKIRT

Little girl's simple, elastic-waist skirt with unique ribbon hem detail. No pattern required.



SEWING INSTRUCTIONS

materials needed:

44"-45"-wide lightweight cotton or linen fabric
(see Fabric Note below)

3/4"-wide elastic, in a length to fit wearer's waist

1 1/2 yards of ribbon in any width greater than 1/4"

Matching thread

Fabric Note: For this skirt, you'll use the full width of fabric from selvedge to selvedge. Determine how long you'd like the finished length of the skirt to be; then add 2" to that measurement and cut the fabric that length from selvedge to selvedge.

Stitch Note: The term "edgestitch" means to straight-stitch from the right side, 1/8" from and parallel to an edge, seam, or another stitching line, using your presser foot as a guide.

make the waistband

1 Fold the cut skirt panel in half, with the fabric's right sides together, and align and pin the selvedge edges. Join the pinned edges with a 1/2" seam (or stitch just inside the fabric's selvages, which may be wider than 1/2" depending on the manufacturer).

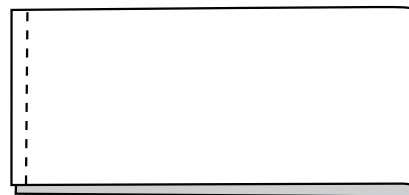

2 Press the seam allowances open, but don't worry about finishing them since the selvages are still intact.

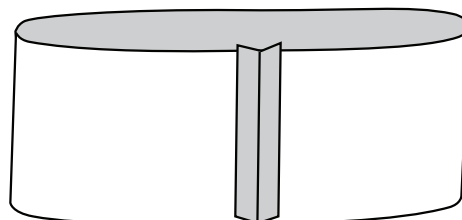

• a free pattern from • **oliver + s** • not for resale •



3 Fold and press the skirt's top edge twice to the wrong side—first, 1/2" and then 7/8". Then edgestitch the waistband's lower folded edge, leaving about 2" un-sewn at the selvedge seam for feeding the elastic through the waistband.

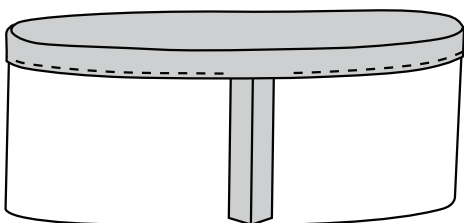

4 Pin a bodkin or safety pin to one end of the elastic, and feed the elastic into the waistband casing through the opening. Work the elastic's pinned end through the casing and back out the opening.

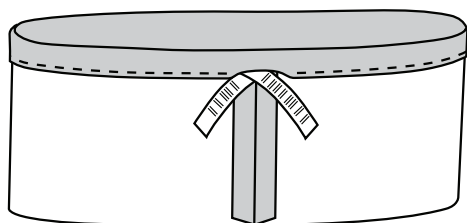

5 Trim the elastic to the desired length. Next overlap the two ends by about 3/4", and pin them together. Then sew the pinned ends together by stitching a tiny rectangle on the overlapped edges, removing the pin and lockstitching at the beginning and end of the rectangle.

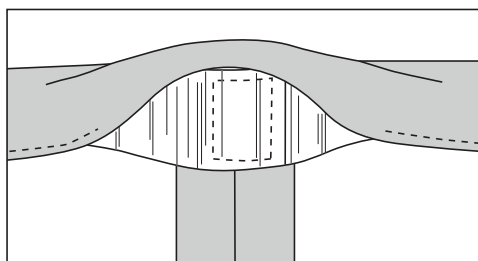

6 Finish edgestitching the casing's opening to close it.

sew the ribbon hem

1 Working on the wrong side of the skirt, pin the ribbon to the skirt's hem, aligning the top edge of the ribbon 1/2" above the skirts' raw edge.

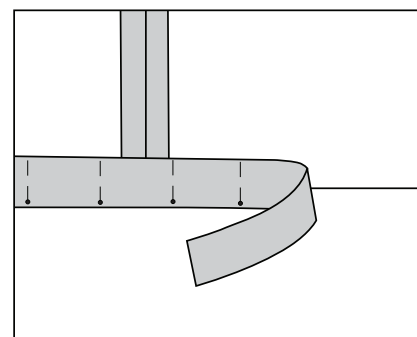

2 Edgestitch the ribbon's top edge to the skirt. This edge will become the bottom of the hem in step 4. Finish the two ends of the ribbon by folding one end 1/2" to the wrong side and then overlapping this end over the other raw end, as shown below.

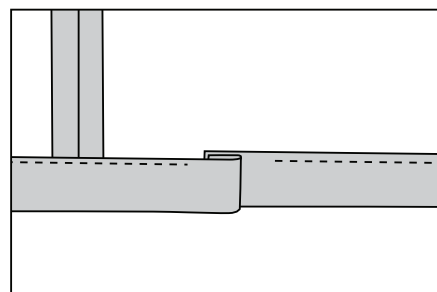

3 Trim the skirt fabric below the edgestitching on the ribbon, so the fabric extends about 1/8" beyond the edgestitching.

4 Fold the ribbon to the right side of the skirt, and press it in place. Then edgestitch the ribbon's remaining edge (now its top edge) to finish the hem. The raw edge of the skirt fabric's hem is now encased between the two rows on stitching on the ribbon, clean-finishing the hem on both sides of the skirt.

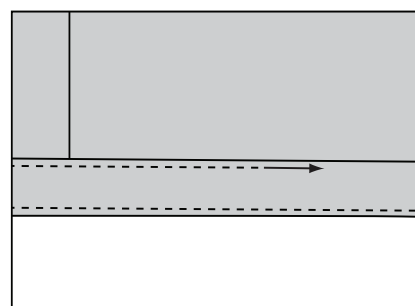

5 You're finished! And there's plenty of time to enjoy the rest of the afternoon while sitting on the porch swing.